

NO.	Item	Length	QTY
1	2060 TOP Rail	1930	1
2	2060 Bottom Rail	1930	1
3	AL Insert	1930	1
4	6078 TG	1189.26	12
5	TG U-Channle	1115.60	2
6	5050 Post	2387.60	2



Design by  
 Check by  
 Approve by  
 Complete date

Product name  
 Drawing NO  
 Revision

DP56x78.7-6078-AF

A/O

Sheet 1

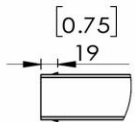
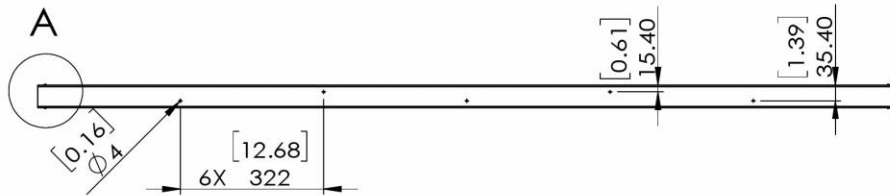
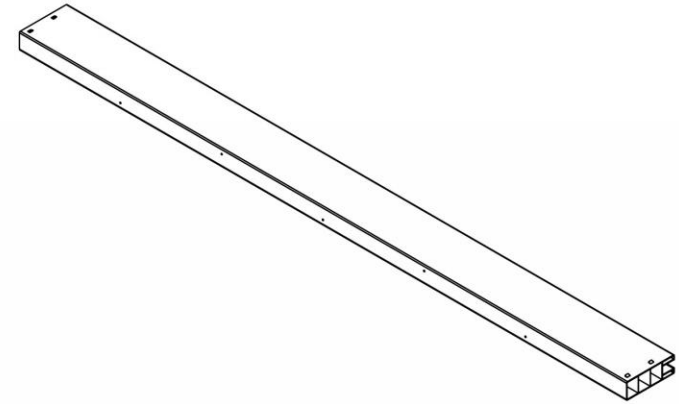
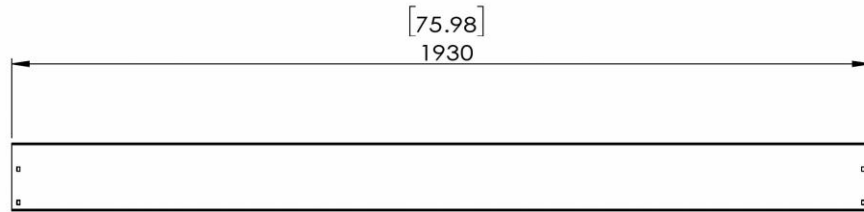

比例 1 : 6

**Spread  
Eagles**

Design by		Product name	2060 Bottom Rail	
Check by				
Approve by		Drawing NO		
Complete date		Revision	A/0	Sheet 2

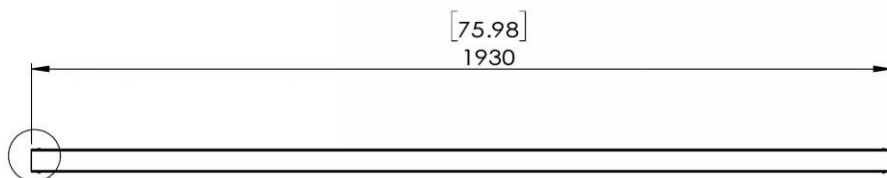
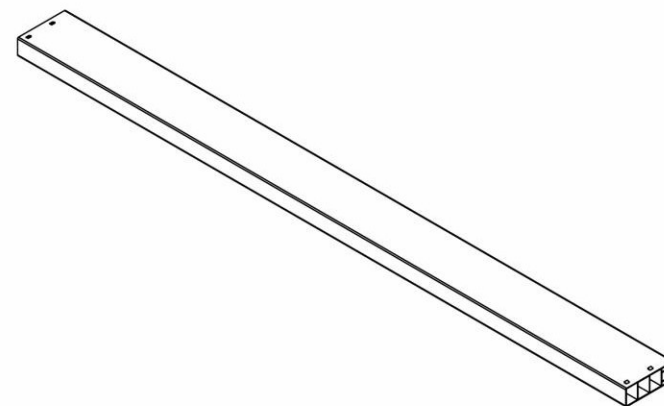

B

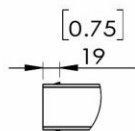

B

比例 1 : 6

**Spread  
Eagles**

Design by		Product name	2060 TOP Rail	
Check by				
Approve by		Drawing NO		
Complete date		Revision	A/0	Sheet 3

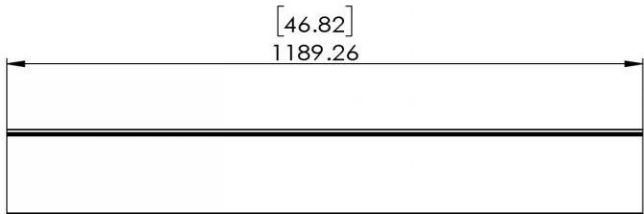
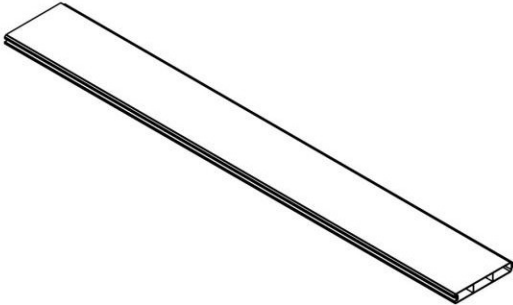

**Spread  
Eagles**

Design by  
Check by  
Approve by  
Complete date

Product name  
Drawing NO  
Revision

6078 TG

A/0

Sheet 4

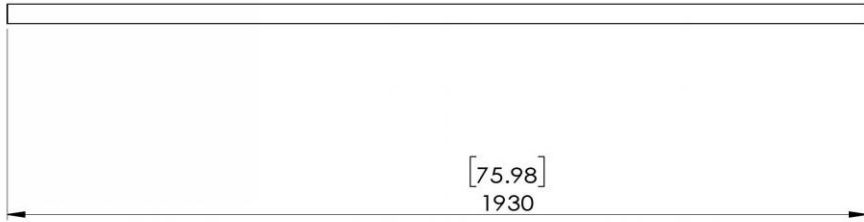
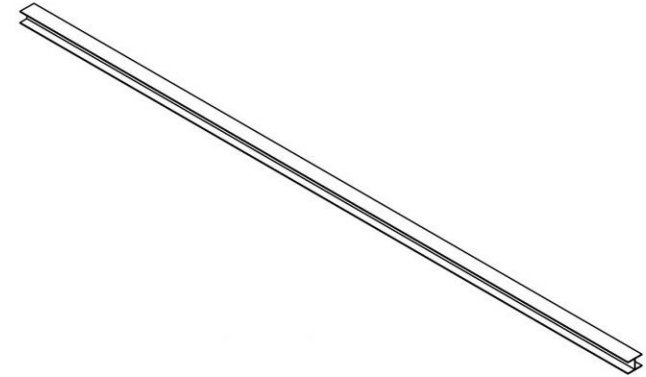

H



Design by		Product name	AL Insert	
Check by				
Approve by		Drawing NO		
Complete date		Revision	A/0	Sheet 5

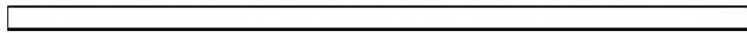
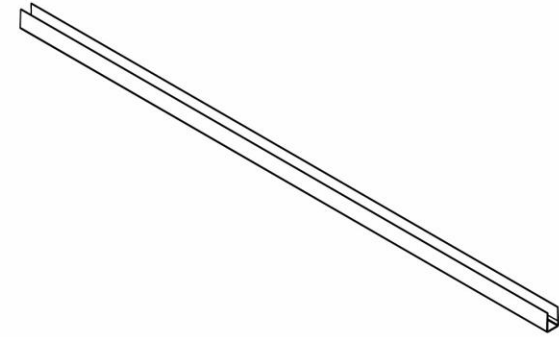
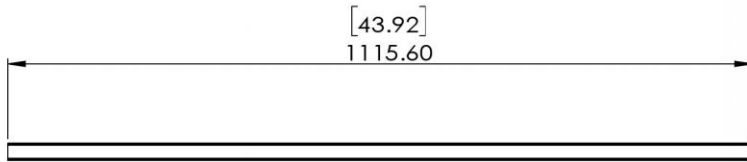

<b>Spread Eagles</b>	Design by		Product name	TG U-Channle	
	Check by		Drawing NO		
	Approve by		Revision	A/0	Sheet 6
	Complete date				